



ROYAL CLIMA

SERVICE MANUAL

AIRCONDITIONER

Duct

SUPER DC INVERTER MULTI TYPE
2018

RCI-DM09

RCI-DM12

RCI-DM18

DC MULTI INDOOR UNITS



CONTENTS

1. General information of Indoor Units	1
2. Features	2
3. Dimensions	5
4. Service Space (unit: mm)	6
5. Wiring diagram	7
6. Static Pressure (Duct)	8
7. Operation temperature range	12
8. Electronic function	13
8.1 Abbreviation	13
8.2 Icon explanation on indoor display board	13
8.3 Main Protection	13
8.4 Operation Modes and Functions.....	14

1. General information of Indoor Units

A5 Duct



Model					
	A5 Duct				
	RCI-DM09				
	RCI-DM12				
	RCI-DM18				

2.2 A5 Duct

(1) Easy Installation: Two air inlet styles (Bottom side or Rear side)

- Air inlet from rear is standard for all capacity; air inlet from bottom is optional.
- The size of air inlet frame from rear and bottom is same, it's very easy to move the cover from bottom to rear side, or from rear to the bottom, in order to matching the installation condition.



Air intake from bottom (Optional)

(2) Fresh air intake function

- Install one duct from the reserved fresh-air intake to outdoor.
Continually inhale the fresh air to improve the quality of the indoor air, fulfills air quality more healthy and comfortable.

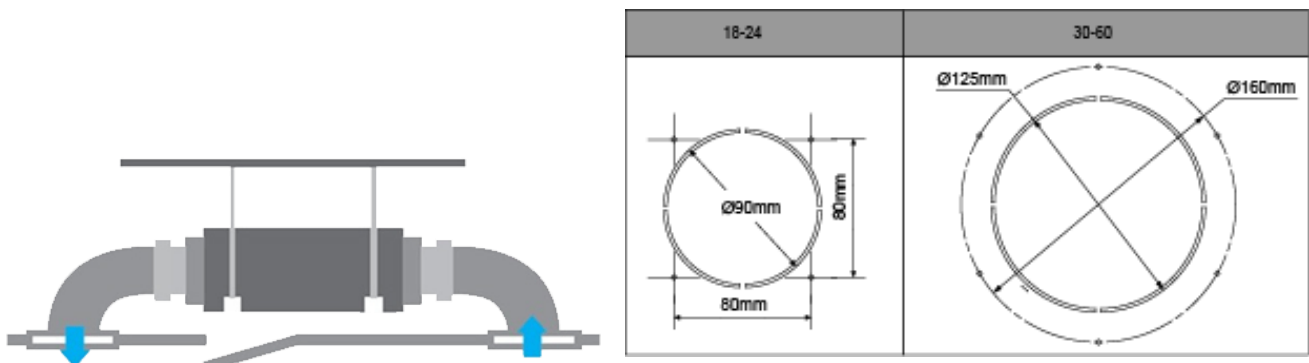

(3) Easy maintenance

- Clean the filter (Optional, standard product without filter)
It is easy to draw out the filter from the indoor unit for cleaning, even the filter is installed in rear side or bottom side.

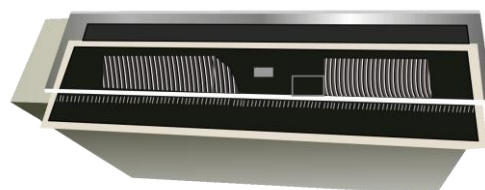
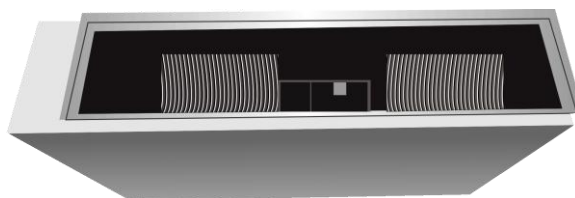

- Replace the motor or centrifugal fan

Remove the ventilated panel firstly. Remove a half of blower housing and take out the motor with centrifugal fan. Directly remove two bolts, and then replace the motor or centrifugal fan easily.

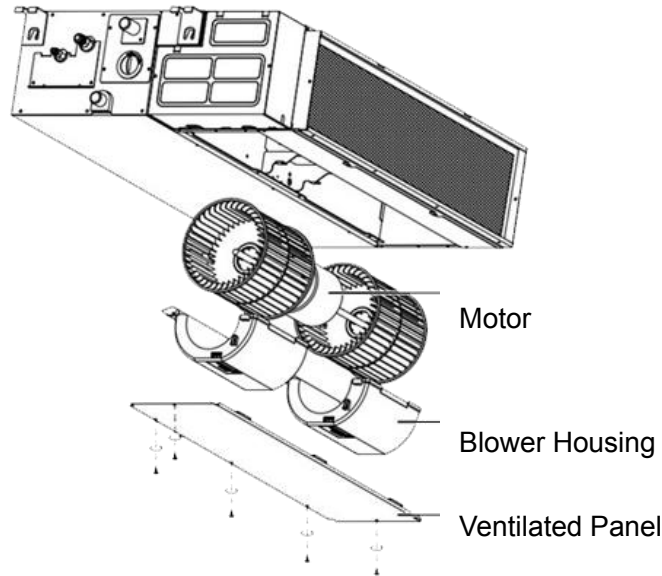

(4) Reserved remote on-off and central control ports

- Reserved remote on-off ports and central control ports, can connect the cable of an on-off controller or a central controller to realize remote on-off control function or group control function.

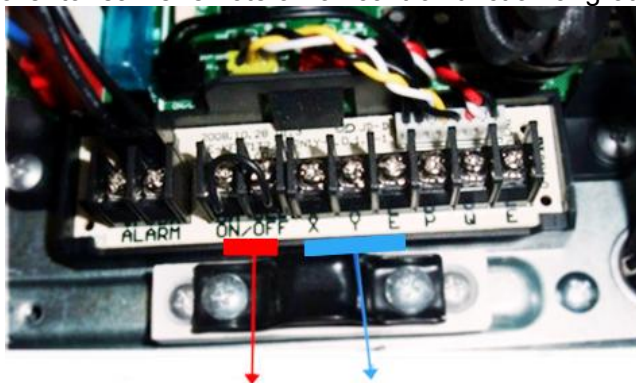

Remote on-off ports Central control ports

(5) Built-in drain pump (Optional):

- Built-in drain pump can lift the water to 750mm upmost. It's convenient to install drainage piping under most space condition.
-

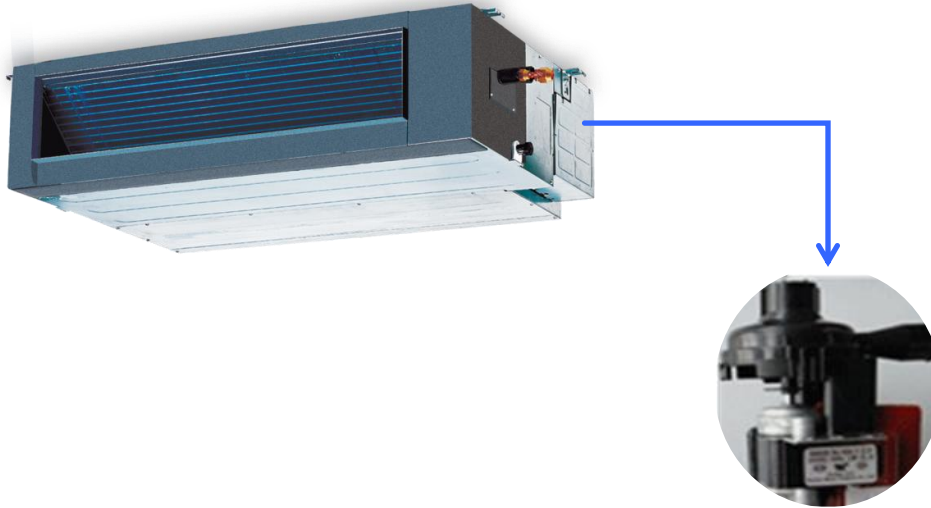
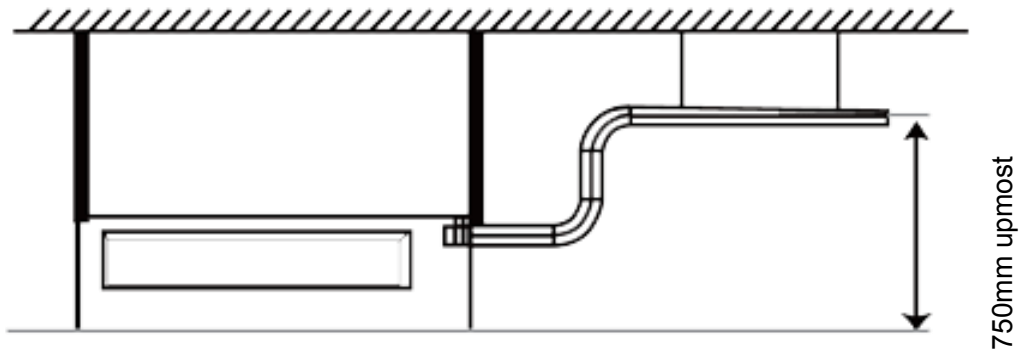

(6) Built-in display board

- The standard indoor unit can be controlled by wired controller.
- There is a display board with a receiver in the E-box. Move out the display, and fix it in other place, even in the distance of 10m. The unit will realized remoter control.
- The wired controller and the display board can display the error code or production code when the chips detect some failure.

Wired Controller (Standard)

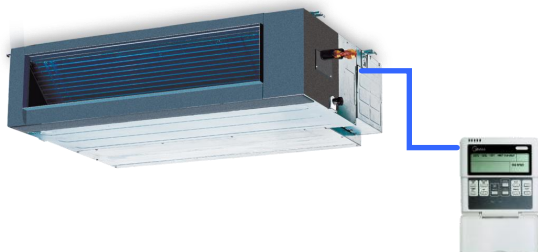

Remote Controller (Optional)

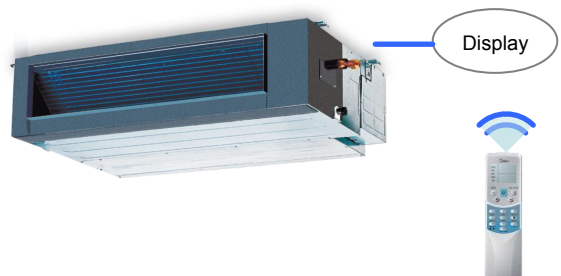

3.2 A5 Duct

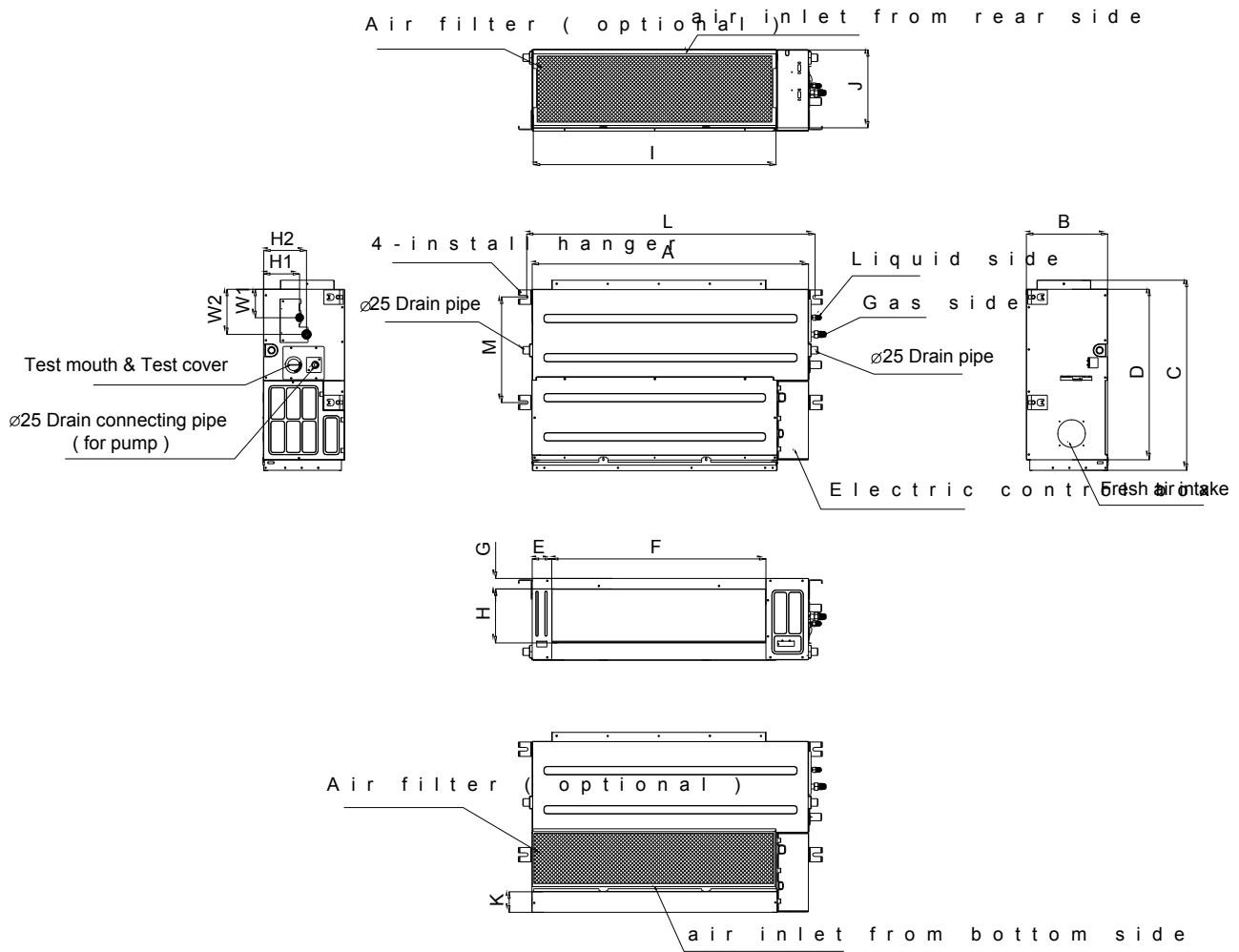

Note: standard product without filter Unit: mm

Model	Outline dimension(mm)				Air outlet opening size				Air return opening size			Size of install hanger		Size of refrigerant pipe			
	A	B	C	D	E	F	G	H	I	J	K	L	M	H1	H2	W1	W2
09/12	700	210	635	570	65	493	35	119	595	200	80	740	350	120	143	95	150
18	920	270	635	570	65	713	35	179	815	260	20	960	350	120	143	95	150

4. Service Space (unit: mm)

4.2 A5 Duct

Ensure enough space required for installation and maintenance.

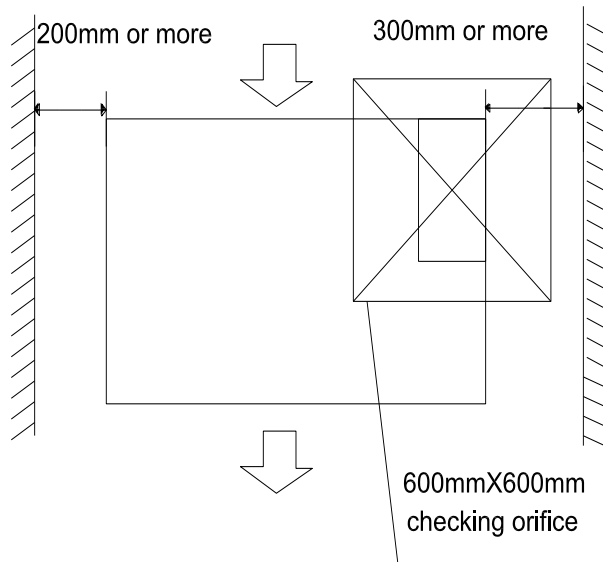

All the indoor units reserve the hole to joint the fresh air pipe. The hole size as following:

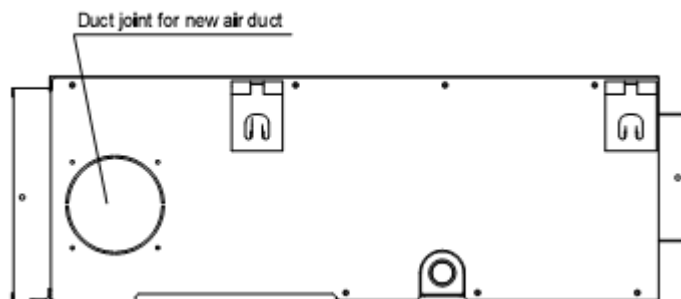

5. Wiring diagram RCI-DM09, RCI-DM12

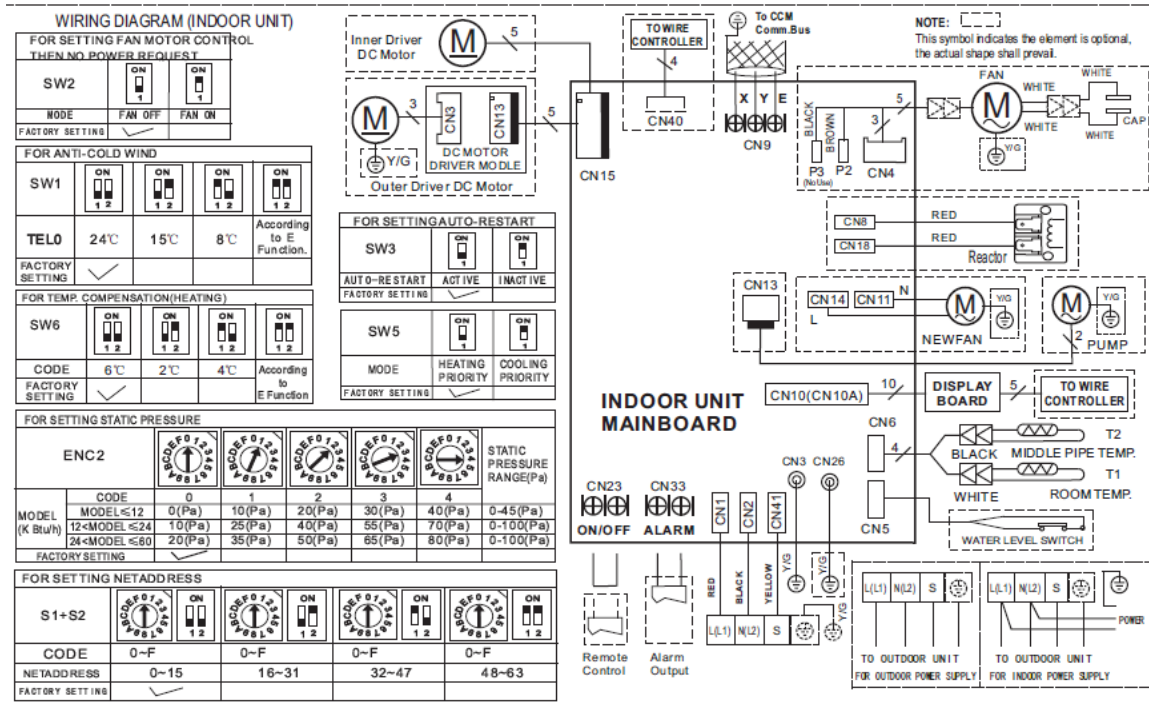

RCI-DM18

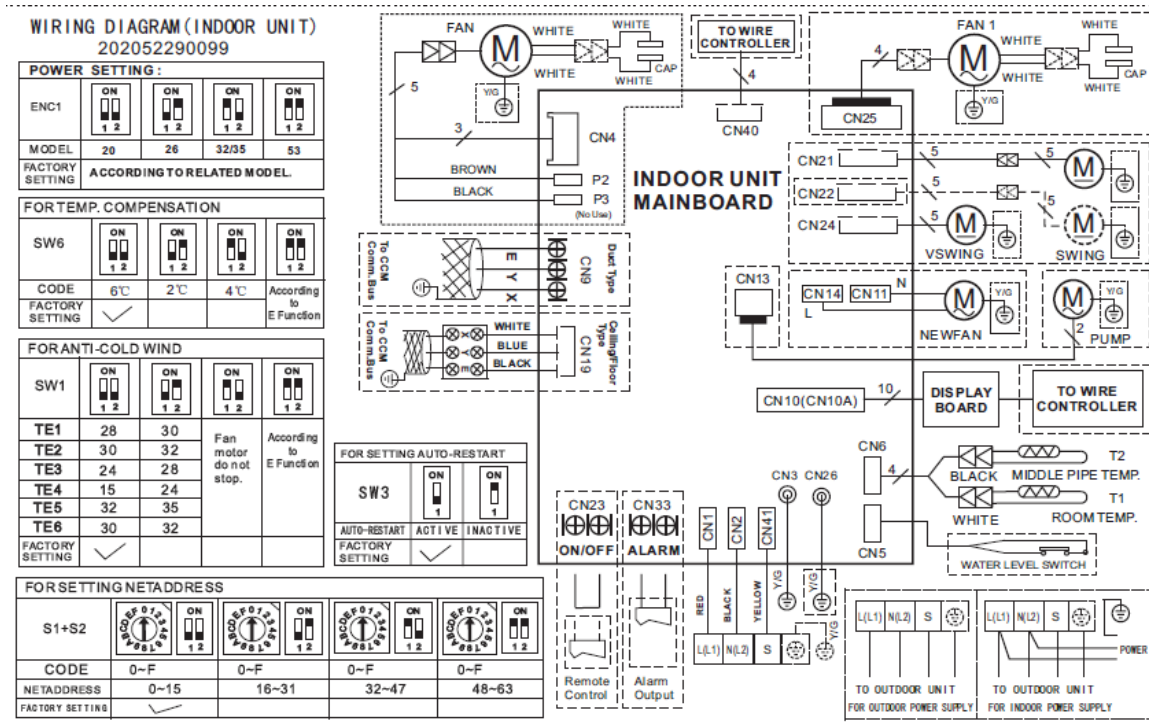

6. Static Pressure (Duct)

RCI-DM09

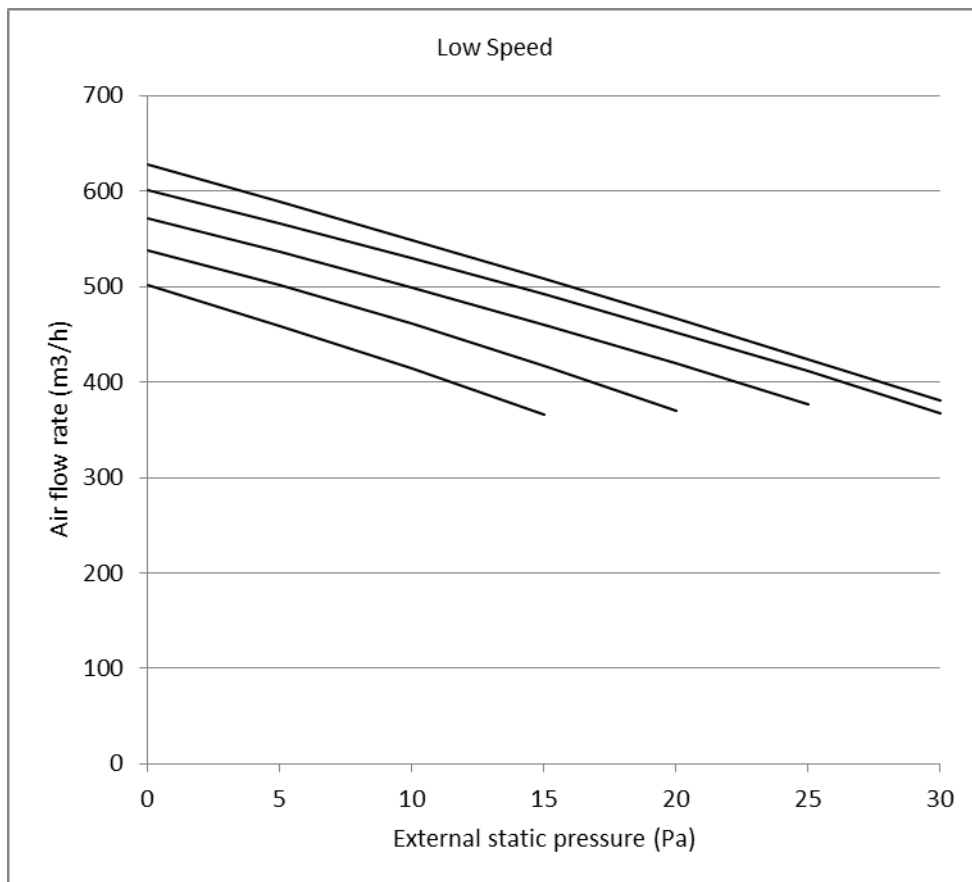
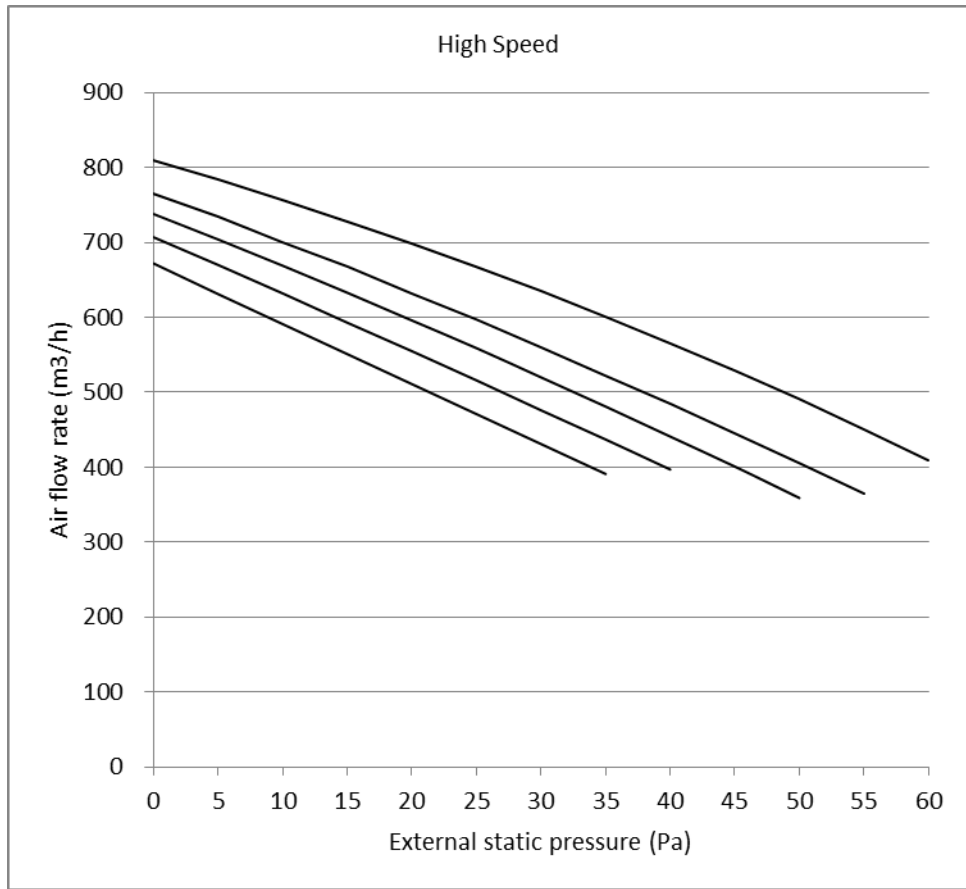

RCI-DM12

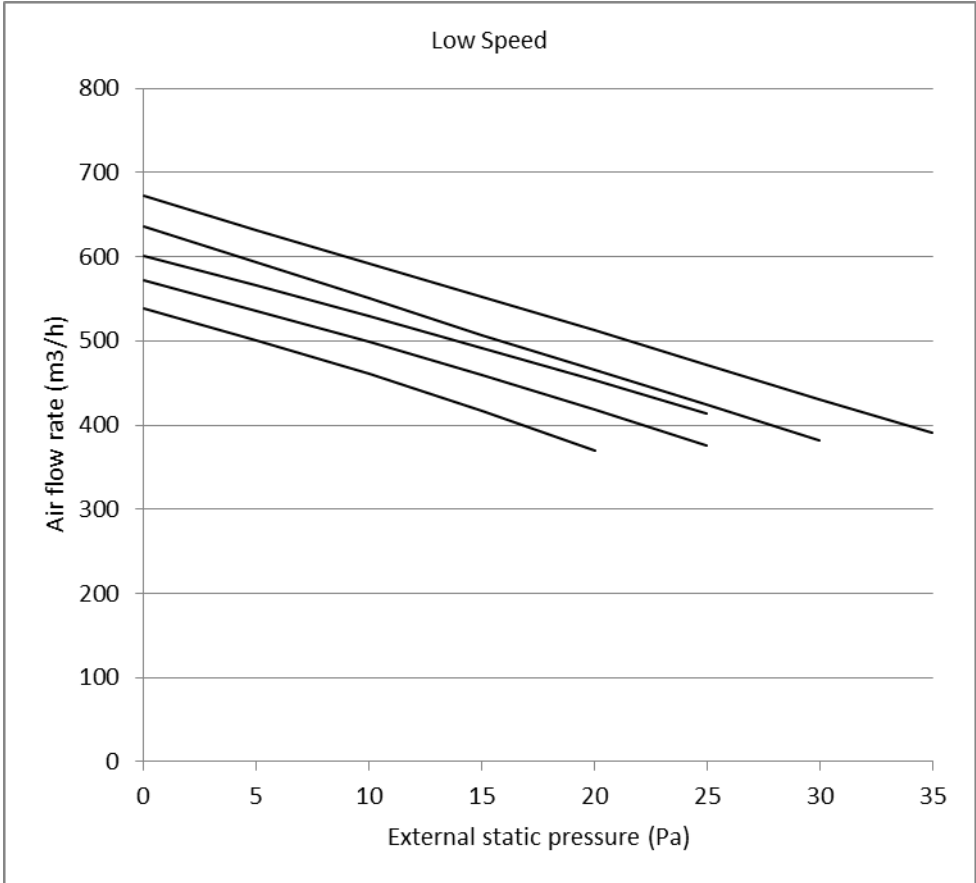
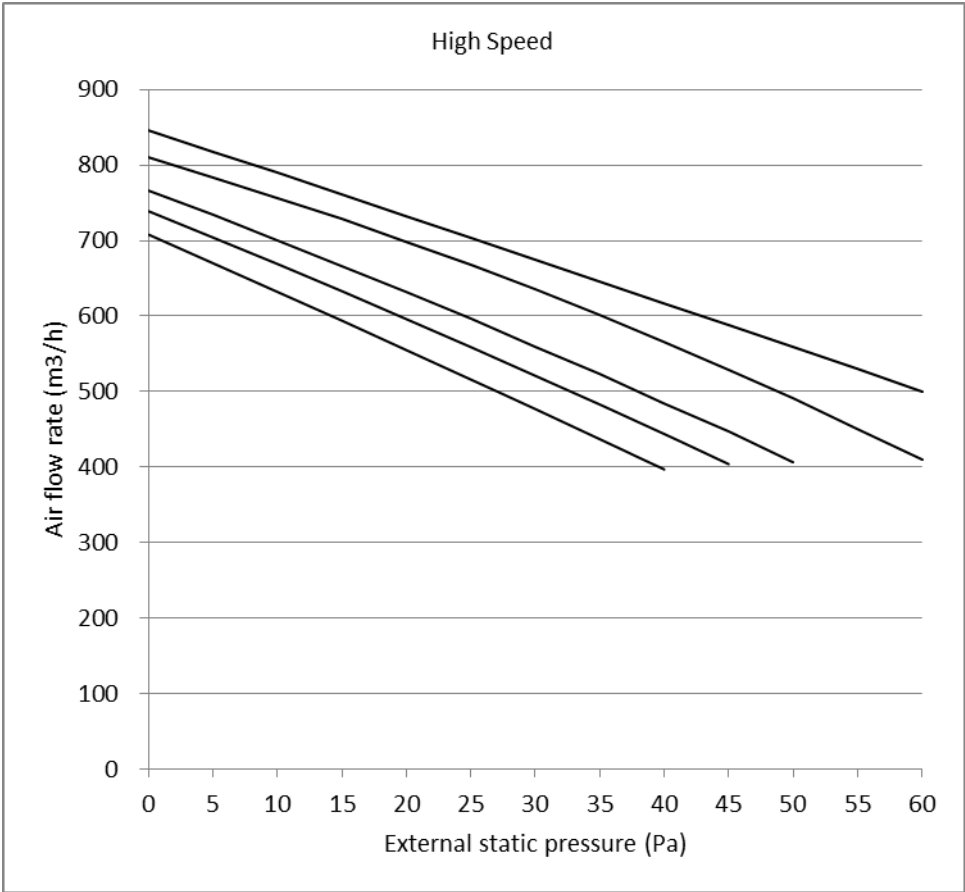

RCI-DM18

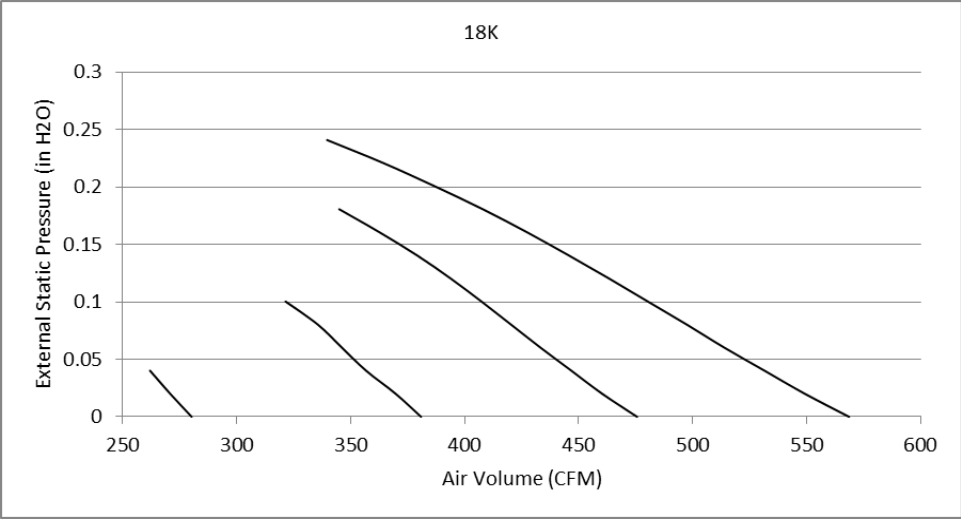

RCI-DM12

High Speed

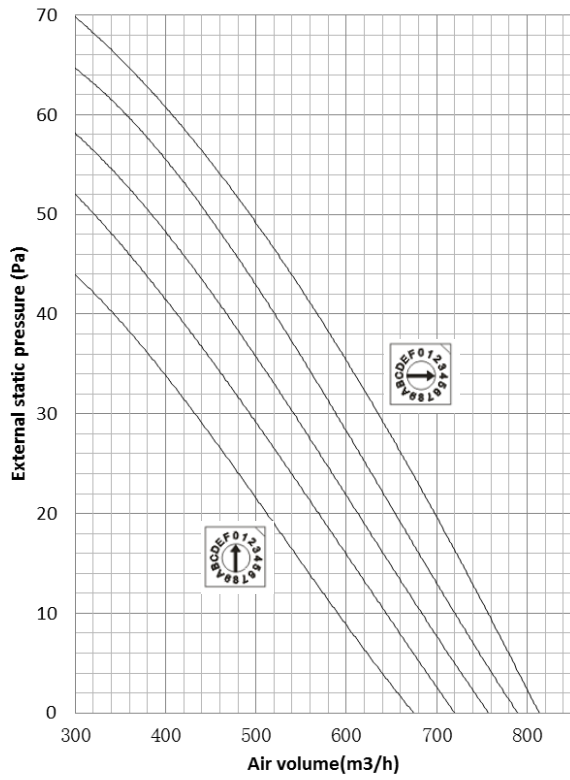

Low Speed

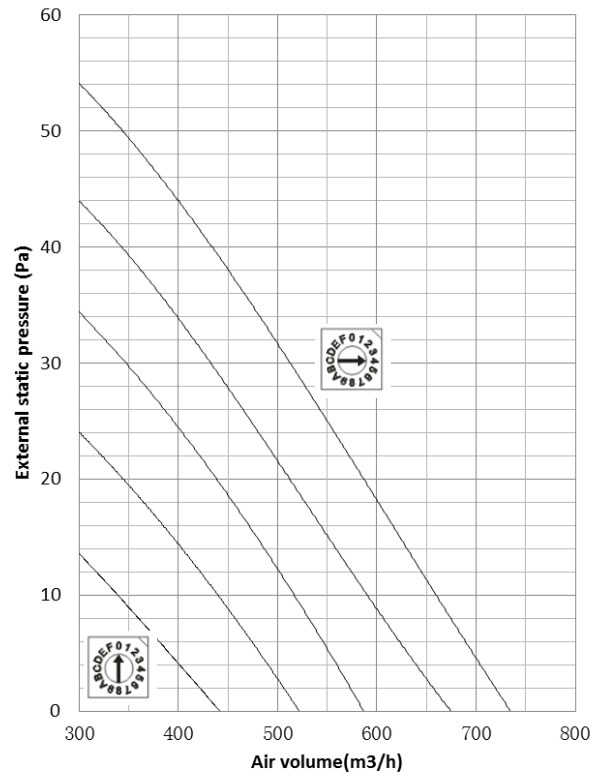

7. Operation temperature range

Temperature Mode	Cooling operation	Heating operation	Drying operation
Room temperature	17°C~32°C	0°C~30°C	17°C~32°C
Outdoor temperature	0°C~50°C	-15°C~24°C	0°C~50°C
	(-15°C~50°C: For the models with low temperature cooling system)		

CAUTION:

1. If the air conditioner is used beyond the above conditions, certain safety protection features may come into operation and cause the unit to operate abnormally.
2. The room relative humidity should be less than 80%. If the air conditioner operates beyond this figure, the surface of the air conditioner may attract condensation. Please set the vertical air flow louver to its maximum angle (vertically to the floor), and set HIGH fan mode.
3. The optimum performance will be achieved during this operating temperature zone.

8. Electronic function

8.1 Abbreviation

T1: Indoor room temperature

T2: Indoor evaporator temperature

T2B: Coil temperature of indoor heat exchanger outlet(This sensor is located in outdoor unit)

T3: Coil temperature of outdoor heat exchanger

T4: Outdoor ambient temperature

T5: Compressor discharge temperature

Ts: Setting temperature

8.2 Icon explanation on indoor display board

8.2.1 Four-way cassette (compact)

8.2.2 A5 Duct

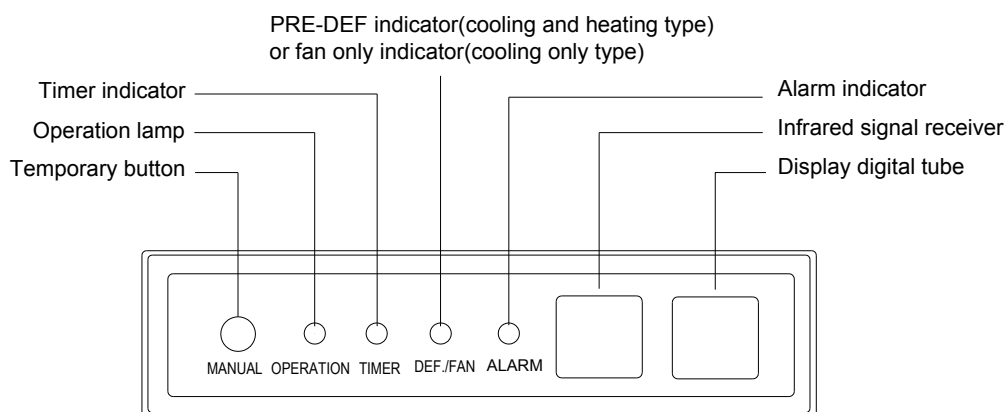

8.3 Main Protection

8.3.1 Three minutes delay at restart for compressor.

8.3.2 Sensor protection at open circuit and breaking disconnection.

8.3.3 Indoor fan delayed open function

---When system starts up, the louver will be active immediately, and the indoor fan will open after certain time.

---If the system runs in heating mode, the anti-cold wind function has priority.

8.3.4 Fan speed is out of control (For the units used DC fan motor)

For console:

When indoor fan speed keeps too low (300RPM) for certain time, the unit will stop and the LED will display the failure.

For other models:

When indoor fan speed keeps too low (lower than 300 RPM) for 50s, the indoor fan will shut off and restart 30s later, if protection happened 3 times when fan motor restart continuously, the unit will stop and the LED will display the failure.

8.3.5 Inverter module protection

The Inverter module has a protection function about current, voltage and temperature. If these protections happen, the corresponding code will display on indoor unit and the unit will stop working.

8.4 Operation Modes and Functions

8.4.1 Fan-only mode

(1) Outdoor fan and compressor stop.

(2) For Console: Indoor fan can be set to high/med/low/breeze, for other models: Indoor fan can be set to high/med/low/auto.

(3) The louver operates same as in cooling mode.

(4) Auto fan in fan-only mode acts as follow:

For 1

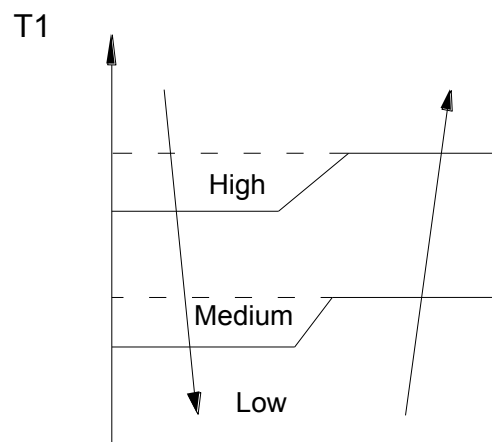

For other models:

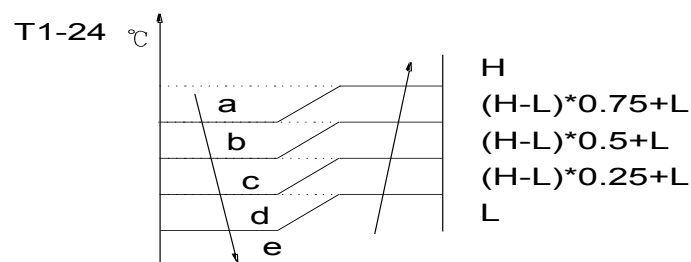

8.4.2 Cooling mode

8.4.2.1 Outdoor fan running rules

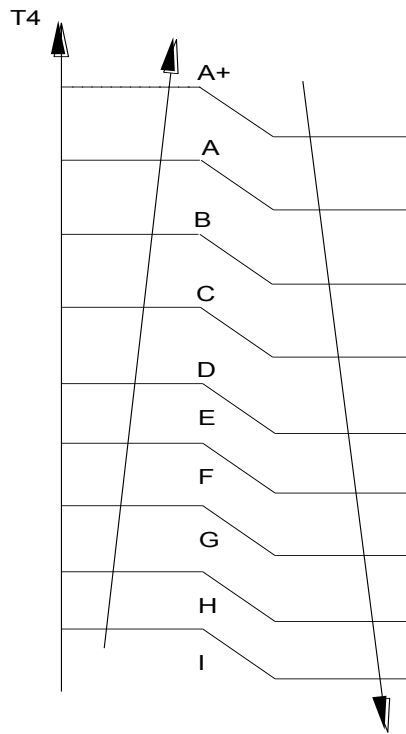

While A,B,C...means different fan speed of outdoor unit.

8.4.2.2 Indoor fan running rules

For models:

In cooling mode, indoor fan runs all the time and the speed can be selected as high, medium, low and auto.

When the compressor is running, the indoor fan is controlled as below:

Setting fan speed	T1-Td °C(°F)	Actual fan speed
H	A	H+ (H+=H+G)
	B	H (=H)
	C	H- (H-=H-G)
M	D	M+ (M+=M+Z)
	E	M (M=M)
	F	M- (M-=M-Z)
L	G	L+ (L+=L+D)
	H	L (L=L)
	I	L- (L-=L-D)

The auto fan acts as below rules:

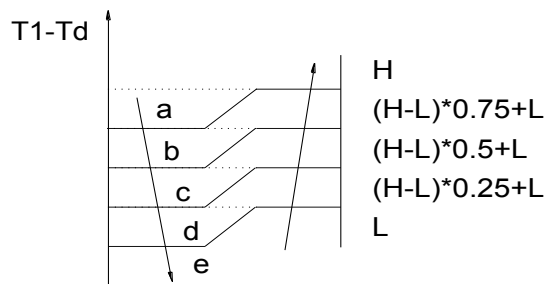

8.4.2.3 Evaporator low temperature T2 protection

For models: When $T_2 < 4^\circ\text{C}$ for 250s or $T_2 < 0^\circ\text{C}$, the indoor has no capacity demand and resume till $T_2 > 8^\circ\text{C}$

8.4.3 Dry mode

8.4.3.1 Indoor fan speed is fixed at breeze and can't be changed. The louver angle is the same as in cooling mode.

8.4.3.2 Low indoor room temperature protection

In drying mode, if room temperature is lower than 10°C , the indoor fan will stop and not resume until room temperature exceeds 12°C .

8.4.3.3 Evaporator anti-freezing protection and condenser high temperature protection are active and the same as that in cooling mode.

8.4.3.4 The outdoor fan operates the same as in cooling mode.

8.4.4 Heating mode

8.4.4.1 Outdoor fan running rules

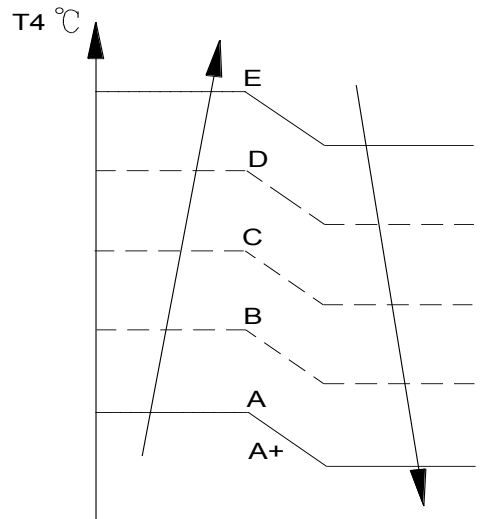

8.4.4.2 Indoor fan running rules

For 1 :

Indoor Fan can be set at HIGH/MED/LOW/AUTO by using a remote controller, but Anti-cold wind function prevails.

Auto wind in heating mode

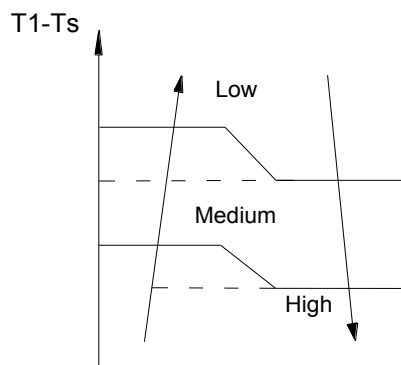

For other models:

In heating mode, indoor fan can be selected as high, medium, low and auto. The anti-cold-wind function has the priority.

When the compressor is running, the indoor fan is controlled as below:

Setting fan speed	T1-Td°C	Actual fan speed
H		H- (H=H-G)
		H (=H)
		H+(H+=H+G)
M		M-(M=M-Z)
		M(M=M)
		M+(M+=M+Z)
L		L-(L=L-D)
		L(L=L)
		L+(L+=L+D)

If the compressor stops caused by the room temperature rising, the indoor fan will be forced to run 127 seconds with breeze. During this period, the anti-cold-wind is disabled.

Auto fan action in heating mode:

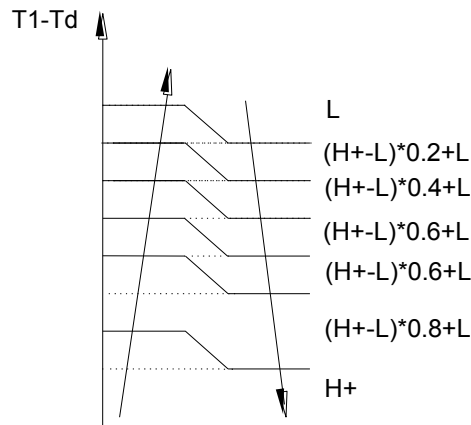

8.4.4.3 High evaporator coil temp.T2 protection:

If $T_2 > 63^\circ\text{C}$, the indoor unit has no capacity demand and resume till 48°C .

8.4.4.4 Prevent Over-Heating

In heating mode, when the indoor unit has no capacity requirement due to indoor room temperature increased, the Indoor fan will run in super breeze. (Anti-cold wind function has the priority)

8.4.4.5 Defrosting mode:

Condition of defrosting:

AC will enter the defrosting mode according to the value of temp. of T3 and the value range of temp. change of T3 and also the compressor running time.

Condition of ending defrosting:

If any one of the following items is satisfied, the defrosting will finish and the machine will turn to normal heating mode.

----T3 rises to be higher than $TCDE1^\circ\text{C}$.

----T3 keeps to be higher than $TCDE2^\circ\text{C}$ for 80 seconds.

----The machine has run for 10 minutes in defrosting mode.

Defrosting action:

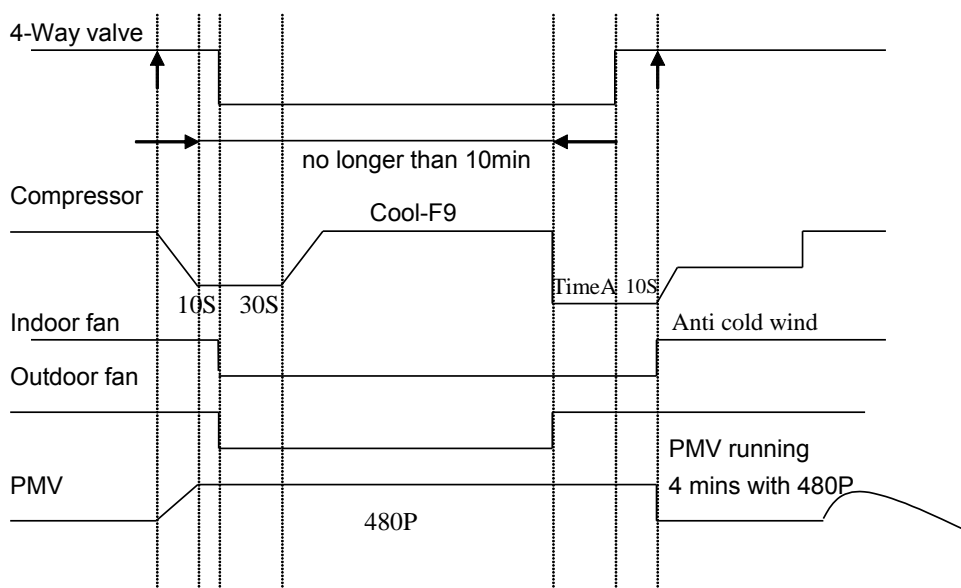

8.4.5 Auto-mode

This mode can be chosen by remote controller and the setting temperature can be changed between 17~30°C.

In auto mode, the machine will choose cooling, heating or fan-only mode according to the difference between T1 and TS.

For 1 :

T1-TS	Running mode
$T1-TS > 1^{\circ}\text{C}$	Cooling
$-1 < T1-TS \leq 1^{\circ}\text{C}$	Fan-only
$T1-TS \leq -1^{\circ}\text{C}$	Heating

For other models:

T1-TS	Running mode
$T1-TS > 2^{\circ}\text{C}$	Cooling
$-2 < T1-TS \leq 2^{\circ}\text{C}$	Fan-only
$T1-TS \leq -2^{\circ}\text{C}$	Heating

Indoor fan will run at auto fan of the relevant mode.

The louver operates same as in relevant mode.

If the machine switches mode between heating and cooling, the compressor will keep stopping for 15 minutes and then choose mode according to T1-Ts.

If the setting temperature is modified, the machine will choose running function again.

8.4.6 Forced operation function

8.4.6.1 Enter forced operation function:

Press the touch button continually, the AC will run as below sequence:

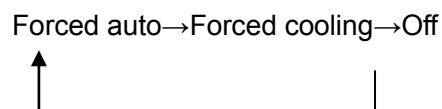

When the machine is off, pressing the touch button will carry the machine to forced auto mode, after this, if pressing the button once again, the machine will turn into forced cooling mode.

In forced cooling mode, pressing touch button will turn off the machine.

8.4.6.2 In forced operation mode, all general protections and remote control are available.

8.4.6.3 Operation rules:

Forced cooling mode:

The compressor runs at F2 frequency and indoor fan runs as breeze. After running for 30 minutes. the machine will turn to auto mode as 24°C setting temperature.

Forced auto mode:

The action of forced auto mode is the same as normal auto mode with 24°C setting temperature.

8.4.6.4 When there's indoor unit running in forced cooling, it is the master forced cooling unit. Other indoor units will run at forced cooling mode too and they will be the slave forced cooling units. The slave forced

cooling units can not quit forced cooling mode until the master forced cooling unit quit, and turn to cooling mode at low speed with 24°C setting temperature.

7.4.6.5 The slave forced cooling units will not be controlled by other signals.

8.4.7 Timer Function

8.4.7.1 Timing range is 24 hours.

8.4.7.2 Timer on. The machine will turn on automatically when reaching the setting time.

8.4.7.3 Timer off. The machine will turn off automatically when reaching the setting time.

8.4.7.4 Timer on/off. The machine will turn on automatically when reaching the setting “on” time, and then turn off automatically when reaching the setting “off” time.

8.4.7.5 Timer off/on. The machine will turn off automatically when reaching the setting “off” time, and then turn on automatically when reaching the setting “on” time.

8.4.7.6 The timer function will not change the AC current operation mode. Suppose AC is off now, it will not start up firstly after setting the “timer off” function. And when reaching the setting time, the timer LED will be off and the AC running mode has not been changed.

8.4.7.7 The setting time is relative time.

8.4.8 Sleep mode

8.4.8.1 The sleep function is available in cooling, heating or auto mode.

8.4.8.2. Operation process in sleep mode is as follow.

After pressing ECONOMIC or SLEEP button on controller, the machine will turn into sleep mode.

When cooling, The set temperature rise 1°C per hour (be lower than 30°C). Two hours later, the set temperature will maintain as a constant and the fan speed is kept at low speed.

When heating, The set temperature decrease 1°C per hour (be higher than 17°C). Two hours later, the set temperature will maintain as a constant and the fan speed is kept at low speed (Anti-cold function takes precedence over all).

When auto, After an hour running under economic mode, if it is under cooling mode the set temp will rise 1°C, if it is under heating mode the set temp will decrease 1°C, if it is under fan-only mode the set temp will be changeless; the condition will be the same after the air conditioner running under economic mode after 2 hours, and during the next time the set temp do not change.

8.4.8.3 Operation time in sleep mode is 7 hours. After 7 hours the AC quits this mode and the AC will turn off.

8.4.8.4 Timer off and remote controller off signals have the priority compared with sleep function.

8.4.9 Auto-Restart function

The indoor unit is equipped with auto-restart function, which is carried out through an auto-restart module. In case of a sudden power failure, the module memorizes the setting conditions before the power failure. The unit will resume the previous operation setting (not including swing function) automatically after 3 minutes when power returns.

If the memorization condition is forced cooling mode, the unit will run in cooling mode for 30 minutes and turn to auto mode as 24°C setting temp.

If AC is off before power off and AC is required to start up now, the compressor will have 1 minute delay when power on. Other conditions, the compressor will have 3 minutes delay when restarts.

8.4.10 Drain pump control (For Duct & Cassette)

Adopt the water-level switch to control the action of drain pump.

Main action under different condition :(every 5 seconds the system will check the water level one time)

1. When the A/C operates with cooling (including auto cooling) and forced cooling mode or dry mode, the pump will start running immediately and continuously, till stop cooling or dry or no capacity demand.
2. Once the water level increase and up to the control point, LED will alarm and the drain pump open and continue checking the water level. If the water level falls down below the control point (drain pump delay close 1 minute) and operate with the last mode. Otherwise the entire system stop operating (including the pump) and LED remain alarming after 3 minutes,

8.4.11 Follow me (optional)

- 1) If the indoor PCB receives the signal which results from pressing the FOLLOW ME button on remote controller, the buzzer will emit a sound and this indicates the follow me function is initiated. But when the indoor PCB receives signal which sent from remote controller every 3 minutes, the buzzer will not respond. When the unit is running with follow-me function, the PCB will control the unit according to the temperature from follow-me signal, and the temperature collection function of room temperature sensor will be shielded, and the error detective function of room temperature sensor will be still invalid.
- 2) When the follow-me function is available, the PCB will not respond according to the setting temperature from follow-me signal every 3 minutes.
- 3) The PCB will take action to the mode change information from remote controller signal, and the follow-me function will be turned off. (if the wired remote controller does not initiate follow me function).
- 4) When the unit is running with follow-me function, if the PCB doesn't receive any signal from remote controller for 7 minutes or pressing FOLLOW ME button again, the follow-me function will be turned off automatically, and the temperature collection function of room temperature sensor will be available, the PCB will control the unit according to the room temperature detected from its own room temperature sensor and setting temperature.
- 5) When the indoor PCB receives the follow-me signal from wired remote controller, the control is the same as that from wireless remote controller, but buzzer will not emit a sound. When the PCB receives turning-off follow-me signal from wired remote controller, the unit will quit follow-me function at once. The follow-me function controlled by wired remote controller prevails that by wireless remote controller.

8.4.12 Mode conflict

The indoor units can not work cooling mode and heating at same time.

Heating mode has a priority.

(1) Definition

	Cooling mode	Heating Mode	Fan	Off
Cooling mode	No	Yes	No	No
Heating Mode	Yes	No	Yes	No
Fan	No	Yes	No	No
Off	No	No	No	No

No: No mode conflict;

Yes: Mode conflict

(2) Unit action

- In case of one Indoor unit working in cooling mode or fan mode, and another indoor unit is set to heating mode, the indoor unit working in cooling mode or fan mode will change to off. The outdoor unit will change to heating mode after compressor stop 3 minutes. .
- In case of one Indoor unit working in heating mode, and another indoor unit is set to cooling mode or fan mode, the indoor unit setting to cooling mode or fan mode will change to stand by. The outdoor unit will continue working in heating mode.

If heating mode stops (not including the indoor unit in heating mode reaching the set temperature), 3 minutes after the outdoor unit restarts and works in cooling mode or fan-only mode.